

Montageanleitung

LED Tagfahrlicht

Mounting instructions

LED Daytime Running Lights

Instructions de montage

LED Feux diurnes

Monteringsanvisning

LED Varselljus

Montagehandleiding

LED Dagrijlichten

Instrucciones de montaje

LED Luces de marcha diurna

Istruzioni di montaggio

LED Luci di marcia diurna

Asennusohjeet

LED Huomiovalot

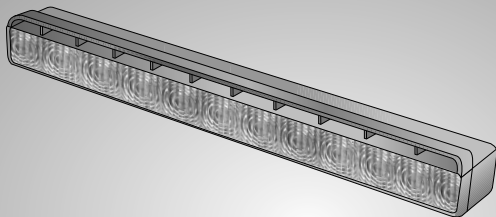

Lieferumfang
Kit includes

Fourniture
Leveransomfattning

Inhoud set
Volumen del suministro

Dotazione die fornitura
Osaluettelo

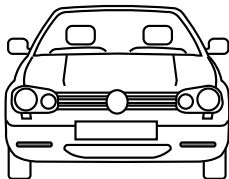
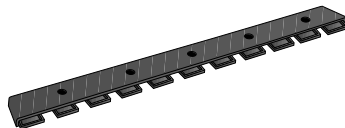
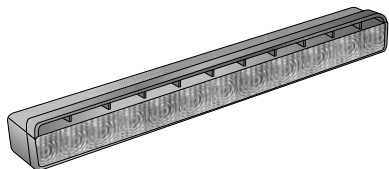

12V  **2PT 980 680-101**

24V  **2PT 980 680-601**

Lieferumfang
Kit includes

Fourniture
Leveransomfattning

Inhoud set
Volumen del suministro

Dotazione die fornitura
Osaluettelo

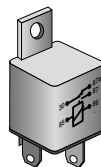
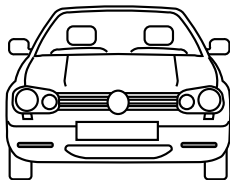
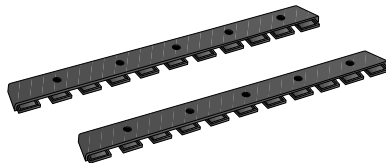
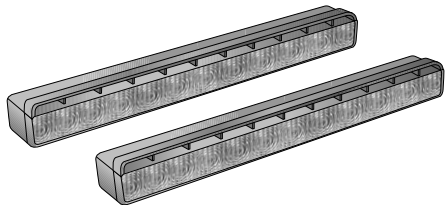

12V  **2PT 980 680-821**

24V  **2PT 980 680-861**

Benötigt Werkzeug
Tools required

Outillage nécessaire
Nödvändiga verktyg

Noodzakelijk gereedschap
Herramientas necesarias

Utensili necessari
Tarvittavat työkalut

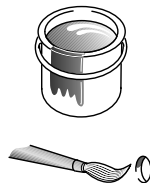
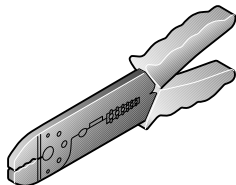
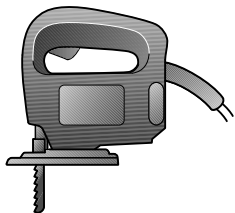

4

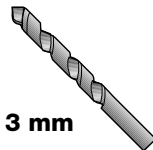
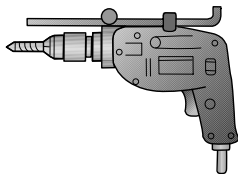

3 mm

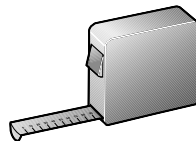
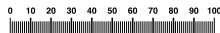

Montage
Mounting

Montage général
Montering

Mantaje
Montaje

Montaggio
Asennus

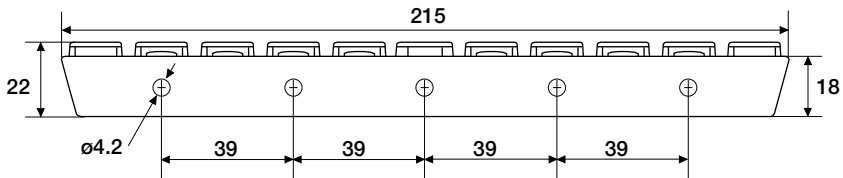
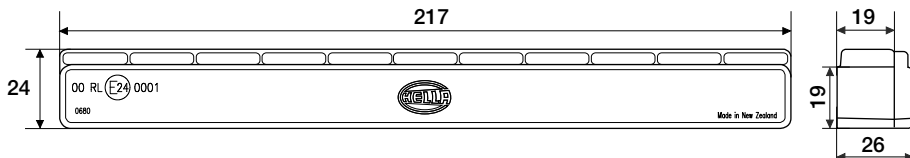

6

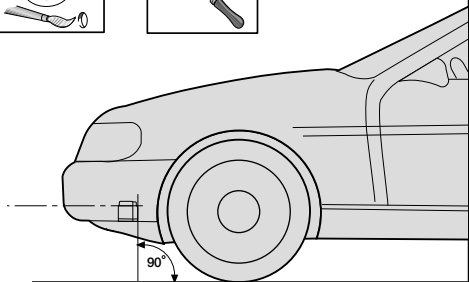
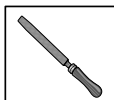
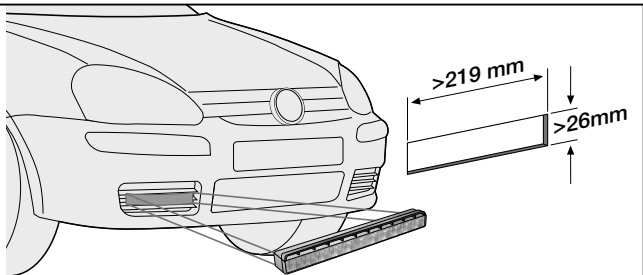
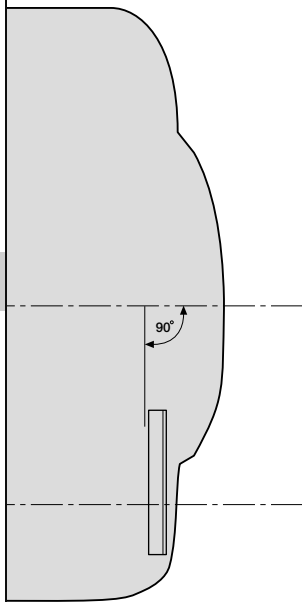

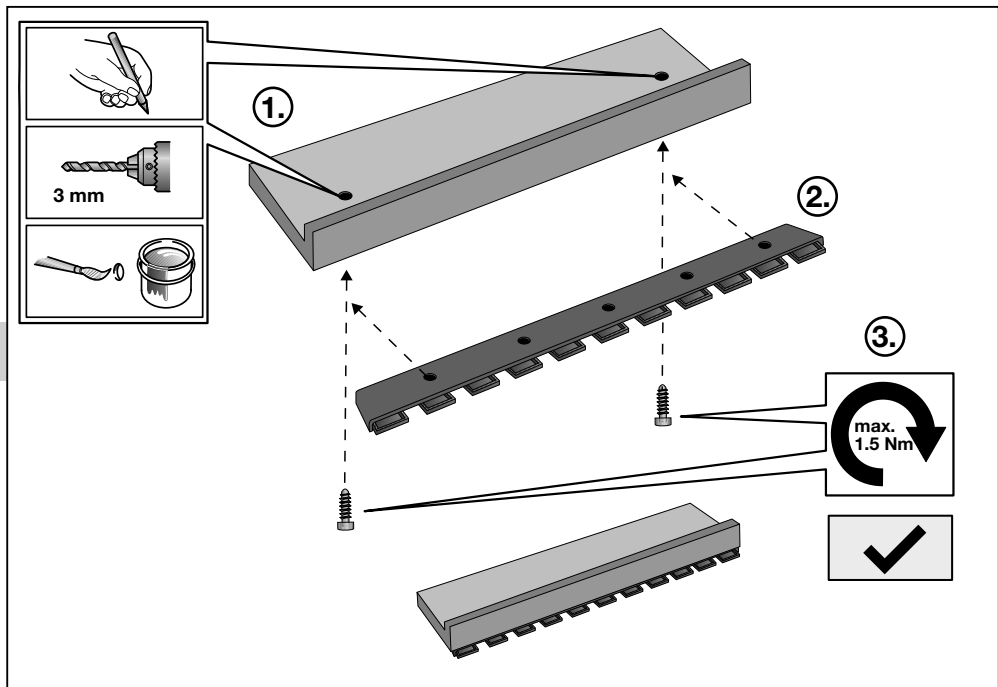

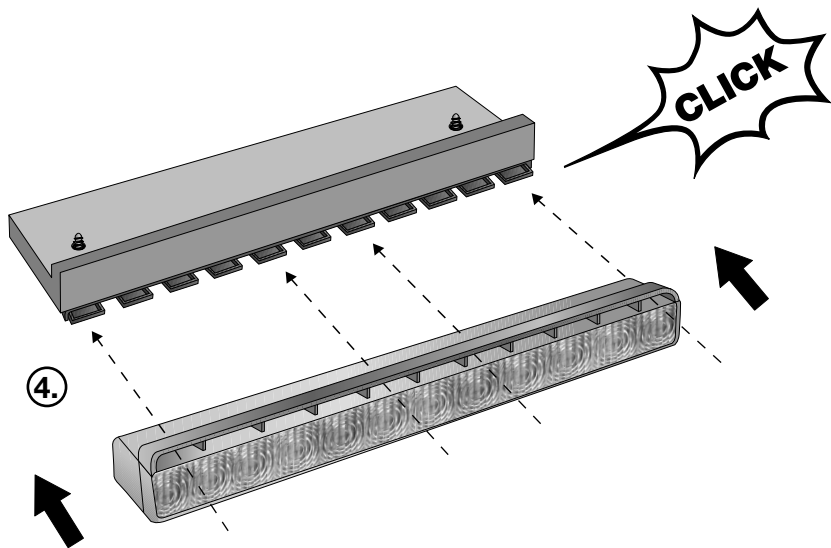

Elektrischer Anschluss
Electrical connection

Connexion électrique
Elektrisk anslutning

Elektrische aansluiting
Conexión eléctrica

Allacciamento elettrico
Sähköliliitäntä

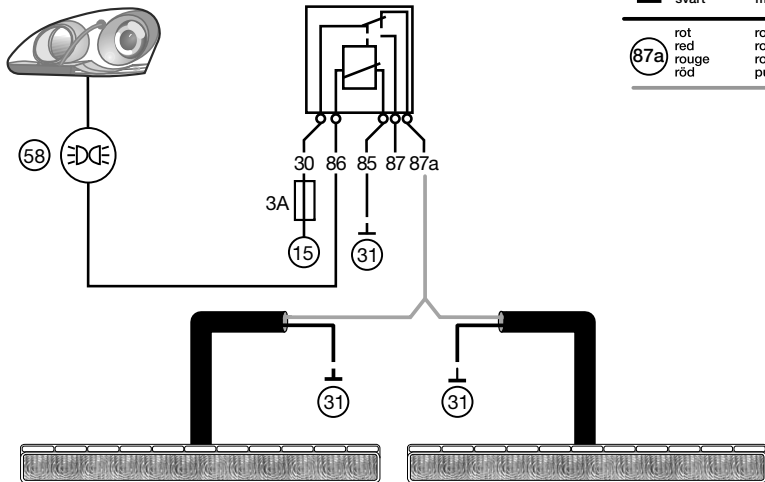

(31) schwarz
black
noir
svart

zwart
negro
nero
musta

(87a) rot
red
rouge
röd

rood
rojo
rosso
punainen

DE

Beleuchtungsanlage auf einwandfreie Funktion hin prüfen. Bei Fragen oder Einbauproblemen, rufen Sie bitte den HELLA Kundendienst, Großhändler an oder wenden Sie sich an Ihre Werkstatt.

EN

Check that the lighting system is working perfectly. If you have questions or installation problems, please call the HELLA Service, wholesaler, or turn to your garage.

FR

Contrôler le bon fonctionnement de l' installation d' éclairage. Pour toutes questions ou problèmes de montage, merci de contacter le service après-vente HELLA, votre distributeur ou votre garage.

SV

Kontrollera att ljussystemet fungerar felfritt. Vid frågor eller monteringsproblem, kontakta Hella kundtjänst, återförsäljaren eller din verkstad.

NL

Controleer of de verlichting goed functioneert. In geval van vragen of montageproblemen verzoeken wij u contact met de HELLA-klantenservice, de groothandel of uw dealer op te nemen.

ES

Comprobar que el sistema de iluminación funciona impecablemente. En caso de dudas o problemas de montaje, por favor, llame al Servicio postventa de Hella o al mayorista, o bien dirijase a su taller.

IT

Controllare la perfetta funzionalità dell' impianto di illuminazione. Per qualsiasi domanda o problemi di montaggio si prega di contattare il servizio assistenza o il proprio grossista HELLA oppure di rivolgersi alla propria officina.

FI

Tarkasta valaistusjärjestelmän toiminta. Jos sinulla on kysymyksiä tai asennusongelmia, soita HELLA-asiakaspalvelulle tai tukkuliikkeelle tai käänny korjaamon puoleen.

DE

Technische Änderungen vorbehalten

Seite **12****EN**

Subject to alteration without notice

Page **13****FR**

Sous réserve de modifications techniques

Page **14****SV**

Vi reserverar oss för tekniska ändringar

Sidan **15****NL**

Technische wijzigingen voorbehouden

Bladzijde **16****ES**

Reservadas modificaciones técnicas

Página **17****IT**

Con riserva modifiche tecniche

Pagina **18****FI**

Oikeus teknisiin muutoksiin pidätetään

Sivu **19**

Montage Seite 5

* Bei Fahrzeugen mit einer Breite von < 1300mm muss der Abstand min. 400 mm betragen.

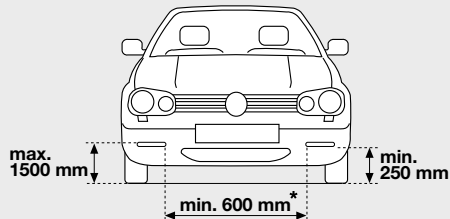

Elektrischer Anschluss Seite 9

Leitungen nach Schaltplan verlegen und anschließen.

Nach Schaltplan werden die Tagfahrleuchten automatisch mit der Zündung eingeschaltet

Achtung!

Tagfahrleuchten:

- sind **kein** Ersatz für Abblendlicht bei Dämmerung oder Dunkelheit.
- leuchten nur bei ausgeschalteter Fahrzeugbeleuchtung und eingeschalteter Zündung.
- schalten sich beim Einschalten der Fahrzeugbeleuchtung automatisch **aus**.
- sind zugelassen gemäß ECE R87.
- dürfen entsprechend der EG-Richtlinie EG R97/28 bzw. ECE R48 angebaut werden.

Wir empfehlen die Montageanleitung mit den KFZ-Papieren mitzuführen.

Mounting Page 5

* With vehicles less than 1300 mm wide, the distance has to be at least 400 mm.

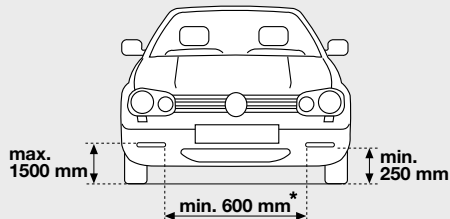

Electrical connection Page 9

Lay and connect the cables in accordance with the connection diagram.

According to the connection diagram, the daytime running lights are switched on automatically with the ignition.

Caution!

Daytime running lights:

- are **not** a substitute for low beam at dawn/dusk or during darkness.
- they shine only when the vehicle lighting is switched off and the ignition is switched on.
- they switch off **automatically** when switching on the vehicle lighting.
- are approved in accordance with ECE R87.
- may be fitted in accordance with EC Directive EC R97/28 and ECE R48.

We recommend that the installation instructions are carried along with the vehicle documentation.

Montage Page 5

* Sur les véhicules d'une largeur <1300 mm, la distance minimale doit être de 400 mm.

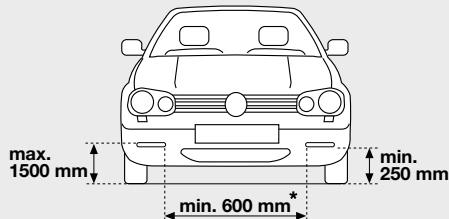
**Branchement électrique Page 9**

Poser et raccorder les câbles suivant le schéma électrique.

D'après le branchement du schéma électrique, les feux diurnes s'allument automatiquement lors de la mise du contact.

Attention !

Les feux diurnes

- ne remplacent pas les feux de croisement au crépuscule ou dans l'obscurité.
- ils ne s'allument que lorsque l'éclairage du véhicule est coupé et que le contact est mis.
- ils s'éteignent **automatiquement** lorsque l'éclairage du véhicule est activé.
- sont homologués conformément à ECE R87
- peuvent être montés conformément à la directive européenne CE R97/28 et/ou ECE R48.

Nous recommandons de conserver l'instruction de montage avec les papiers du véhicule.

Montering Sidan 5

* På fordon med en bredd på < 1 300 mm måste avståndet vara minst 400 mm.

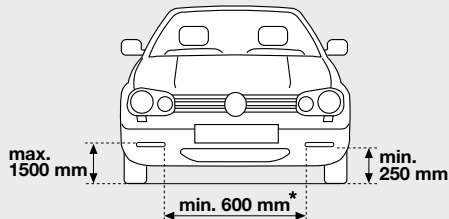
**Elektrisk anslutning Sidan 9**

Dra och anslut ledningarna enligt kopplingschemat.

Enligt kopplingschemat tänds varselljusen automatiskt när tändningen slås på.

Obs!

Varselljus

- Ersätter inte halvljus vid skymning eller i mörker.
- Är endast tända när fordonsbelysningen är släckt och tändningen har slagits på.
- Släcks **automatiskt** när fordonsbelysningen tänds.
- Är godkända enligt ECE R87.
- Får monteras enligt EU-riktlinje 97/28/EG respektive ECE R48.

Vi rekommenderar att du har med monteringsanvisningen i bilen tillsammans med fordonsdokumenten.

Montage Pagina 5

* Bij voertuigen met een breedte <1300 mm dient de afstand min. 400 mm te zijn.

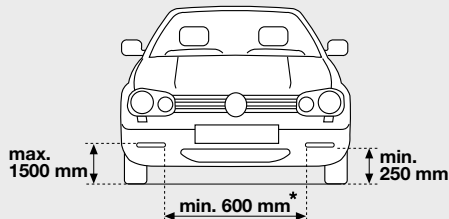

Elektrische aansluiting Pagina 9

Kabels in overeenstemming met schakelschema leggen en aansluiten.

Volgens het schakelschema worden de dagrijlichten automatisch geactiveerd door het omdraaien van de contactsleutel.

Let op!

Dagrijlichten

- zijn bij schemering of duisternis **geen** vervanging voor dimlicht.
- branden alleen als de voertuigverlichting is uitgeschakeld en het contact is ingeschakeld.
- schakelen bij het inschakelen van de voertuigverlichting **automatisch** uit.
- zijn toegelaten volgens ECE R87.
- mogen volgens de EG-richtlijn EG R97/28 of ECE R48 worden ingebouwd.

Wij adviseren de montagehandleiding bij de voertuigpapieren te bewaren.

Montaje Página 5

* En los vehículos con un ancho inferior a 1.300 mm, la distancia debe ser de 400 mm como mínimo.

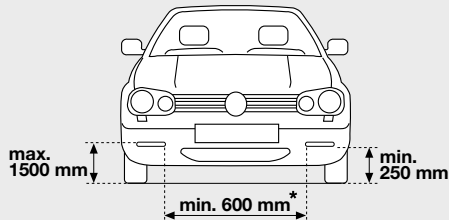

Conexión eléctrica Página 9

Tender y conectar los cables según el esquema de conexiones. Según el esquema de conexiones, los faros diurnos se encienden automáticamente al arrancar el vehículo.

¡Atención!

Faros diurnos

- **No** sustituyen la luz de cruce al atardecer o durante las horas nocturnas.
- Sólo se encienden cuando la iluminación del vehículo está apagada y el encendido está conectado.

Se desconectan **automáticamente** al encender la iluminación del vehículo.

Están homologados según la normativa CEE R87.

Pueden montarse según la directriz europea CE R97/28 o CEE R48.

Recomendamos llevar las instrucciones de montaje junto con los papeles del vehículo.

Montaggio Pagina 5

* Per i veicoli con una larghezza < 1300 mm, la distanza min. deve essere di 400 mm.

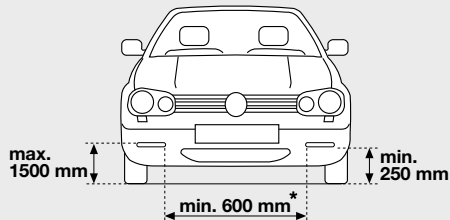
**Collegamento elettrico Pagina 9**

Posizionare i cavi e collegarli in base allo schema elettrico.

Quando si inserisce l'accensione, le luci di marcia diurna si accendono automaticamente in base allo schema.

Attenzione!

Luci di marcia diurna

- **non** possono essere utilizzate al posto delle luci anabbaglianti al crepuscolo o al buio.
- si accendono solo se l'illuminazione del veicolo è disinserita e solo se è stata inserita l'accensione.
- si spengono **automaticamente** attivando l'illuminazione del veicolo.
- sono omologate in base alla normativa ECE R87 devono essere montate in modo conforme alla direttiva CE R97/28 o ECE R48.

Si consiglia di tenere le istruzioni di montaggio con i documenti del veicolo.

Asennus sivu 5

* Vähintään 400 mm erillään toisistaan, jos ajoneuvon leveys on < 1.300 mm.

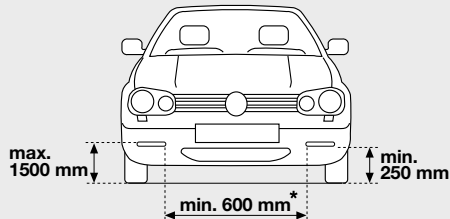
**Sähköinen liitäntä sivu 9**

Asenna johdot kytkentäkaavion mukaan ja liitä.

Kytkenäkaavion mukaan huomiovalot syttyvät automaattisesti virta-avainta käännettäessä.

Huomio!

Huomiovalot

- **eivät** korvaa lähivaloja hämärällä tai pimeällä ajettaessa.
 - palavat vain, kun sytytys on päällä ja ajovalot pois päältä.
 - sammuvat **automaattisesti**, kun ajovalot kytketään päälle.
 - ECE R87-hyväksyntä
 - pinta-asennus sallittu EY-ohjesäännön R97/28 tai ECE-standardin R48 mukaan.
- Suosittelemme asennusohjeen kuljettamista ajoneuvopaperien mukana.**

